

Table 1: Bill of Materials

Schematic: noise_r1.sch
BOM: noise_r1.bom

Tue Aug 22 20:23:04 2006

Wed Aug 23 20:06:46 2006

Qty	Reference	Value	Footprint	Mfg PN	Notes
1	C1	1uF	1206	TDK C3216X7R1H105K	
1	C2	0.01uF	0805	Kemet C0805C103K5RACTU	
1	C3	3300pF	0603	BC VJ0603Y332KXACW1BC	
2	C4, C5	0.1uF	0805	Kemet C0805C104K5RACTU	
1	J1		CON_HDR..	Mill-Max 800-10-005-20-001	
1	Q1		SOT23..	On-Semiconductor BC817-40LT1	
1	R1	100K	0805	Yageo 9C08052A1003FKHFT	
2	R3, R4	4.7M	0805	Yageo RC0805FR-074M7L	
1	R5	1K	0805	Yageo RC0805FR-071KL	
1	R6	3.3K	0805	Rohm MCR10EZHF3301	
1	U1		SOIC..	On-Semiconductor MC33078D	

Table 2: Component List

Schematic: noise_r1.sch
BOM: noise_r1.bom

Tue Aug 22 20:23:04 2006
 Wed Aug 23 20:06:46 2006

Reference	Value	Footprint	Mfg PN	Notes
C1	1uF	1206	TDK C3216X7R1H105K	
C2	0.01uF	0805	Kemet C0805C103K5RACTU	
C3	3300pF	0603	BC VJ0603Y332KXACW1BC	
C4	0.1uF	0805	Kemet C0805C104K5RACTU	
C5	0.1uF	0805	Kemet C0805C104K5RACTU	
J1		CON_HDR..	Mill-Max 800-10-005-20-001	
Q1		SOT23..	On-Semiconductor BC817-40LT1	
R1	100K	0805	Yageo 9C08052A1003FKHFT	
R3	4.7M	0805	Yageo RC0805FR-074M7L	
R4	4.7M	0805	Yageo RC0805FR-074M7L	
R5	1K	0805	Yageo RC0805FR-071KL	
R6	3.3K	0805	Rohm MCR10EZHF3301	
U1		SOIC..	On-Semiconductor MC33078D	

Resistors

Thick film rectangular

MCR10 (2012 size : 1 / 8W)

●Features

- 1) Power rating of 1 / 8W
- 2) Highly reliable chip resistor
Ruthenium oxide dielectric offers superior resistance to the elements.
- 3) Electrodes not corroded by soldering
Thick film makes the electrodes very strong.
- 4) Leading the world in development and mass production.
Since start of production in 1982 (first in the world), this component has established a solid reputation as a general-purpose chip resistor.
- 5) ROHM resistors have approved ISO-9001 certification.
Design and specifications are subject to change without notice. Carefully check the specification sheet before using or ordering it.

●Ratings

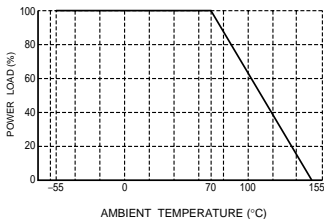
Item	Conditions	Specifications
Rated power	<p>Power must be derated according to the power derating curve in Figure 1 when ambient temperature exceeds 70°C.</p>  <p style="text-align: center;">Fig.1</p>	0.125W (1 / 8W) at 70°C
Rated voltage	<p>The voltage rating is calculated by the following equation. If the value obtained exceeds the limiting element voltage, the voltage rating is equal to the maximum operating voltage.</p> $E = \sqrt{P \times R}$ <p style="text-align: center;">E: Rated voltage (V) P: Rated power (W) R: Nominal resistance (Ω)</p>	Limiting element voltage 150V
Nominal resistance	See Table 1.	
Operating temperature		-55°C to + 155°C



Class 2 X7R 10/16/25/50/100 V

Vishay BCcomponents

Surface Mount Multilayer Chip Capacitors



FEATURES

- Stable class 2 dielectric
- Four standard sizes
- High capacitance per unit volume
- Supplied in tape on reel
- For high frequency applications
- Ni-barrier with 100 % tin terminations.

APPLICATIONS

- Consumer electronics
- Telecommunications
- Data processing

GENERAL SPECIFICATIONS

NOTE: Electrical characteristics values - temperature at 20 ± 1 °C, pressure at 86 to 106 Kpa and humidity at 63 to 67 % unless otherwise stated

Rated Voltage U_R (DC): 10 V; 16 V; 25 V; 50 V; 100 V

Capacitance Range: 100 pF to 1.0 μ F

Tolerance on Capacitance:

After 1000 hours; ± 5 ; ± 10 , ± 20

Tan δ :

50 V ≤ 2.5 %

25 V and 16 V ≤ 3.5 %

10 V ≤ 5 %

Temperature Coefficient: ± 15 %

Insulation Resistance after 120 seconds at U_R (DC):

R_{ins} 10 G Ω minimum or 500 Ω F minimum, whichever is less

Climatic Category (IEC 68): 55/125/56

DIMENSIONS in inches [millimeters]

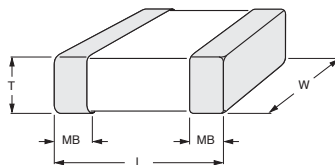

SIZE CODE	L	W	T MAX.	MB
0402	0.040 \pm 0.002 [1.0 \pm 0.05]	0.020 \pm 0.002 [0.5 \pm 0.05]	0.022 [0.55]	0.010 + 0.002/- 0.004 [0.25 +0.05/- 0.1]
0603	0.063 \pm 0.004 [1.6 \pm 0.10]	0.030 \pm 0.004 [0.8 \pm 0.07]	0.035 [0.87]	0.015 \pm 0.006 [0.40 \pm 0.15]
0805	0.080 \pm 0.006 [2.0 \pm 0.15]	0.050 \pm 0.006 [1.25 \pm 0.15]	0.053 [1.35]	0.020 \pm 0.008 [0.50 \pm 0.20]
1206	0.125 \pm 0.006 [3.2 \pm 0.15]	0.063 \pm 0.006 [1.6 \pm 0.15]	0.069 [1.80]	0.025 \pm 0.008 [0.60 \pm 0.20]

ORDERING INFORMATION

VJ0402	Y	101	J	X	Q	C	W1BC
SIZE CODE	DIELECTRIC	CAPACITANCE	TOLERANCE	TERMINATION	VOLTAGE	PACKAGING	TECHNOLOGY
0402 0603 0805 1206	Y = X7R	two significant digits followed by the number of zeros: 101 = 100 102 = 1000 152 = 1500 103 = 10000	J = ± 5 % K = ± 10 % M = ± 20 %	X = Ni Barrier	Q = 10 V J = 16 V X = 25 V A = 50 V B = 100 V	C = 7 inch reel/paper P = 13 inch reel/paper T = 7 inch reel/blister R = 13 inch reel/blister	

MC33078, MC33079

Low Noise Dual/Quad Operational Amplifiers

The MC33078/9 series is a family of high quality monolithic amplifiers employing Bipolar technology with innovative high performance concepts for quality audio and data signal processing applications. This family incorporates the use of high frequency PNP input transistors to produce amplifiers exhibiting low input voltage noise with high gain bandwidth product and slew rate. The all NPN output stage exhibits no deadband crossover distortion, large output voltage swing, excellent phase and gain margins, low open loop high frequency output impedance and symmetrical source and sink AC frequency performance.

The MC33078/9 family offers both dual and quad amplifier versions and is available in the plastic DIP and SOIC packages (P and D suffixes).

Features

- Dual Supply Operation: ± 5.0 V to ± 18 V
- Low Voltage Noise: $4.5 \text{ nV}/\sqrt{\text{Hz}}$
- Low Input Offset Voltage: 0.15 mV
- Low T.C. of Input Offset Voltage: $2.0 \mu\text{V}/^\circ\text{C}$
- Low Total Harmonic Distortion: 0.002%
- High Gain Bandwidth Product: 16 MHz
- High Slew Rate: $7.0 \text{ V}/\mu\text{s}$
- High Open Loop AC Gain: 800 @ 20 kHz
- Excellent Frequency Stability
- Large Output Voltage Swing: $+14.1 \text{ V}/-14.6 \text{ V}$
- ESD Diodes Provided on the Inputs
- Pb-Free Packages are Available

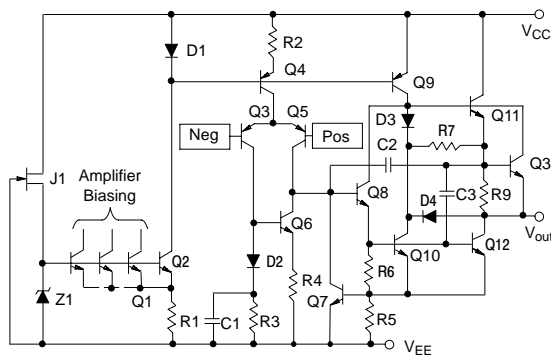

Figure 1. Representative Schematic Diagram (Each Amplifier)



ON Semiconductor®

<http://onsemi.com>

MARKING DIAGRAMS

DUAL

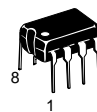

PDIP-8
P SUFFIX
CASE 626

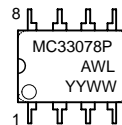

SOIC-8
D SUFFIX
CASE 751

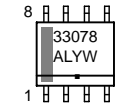

QUAD

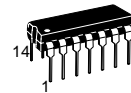

PDIP-14
P SUFFIX
CASE 646

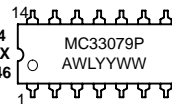

SOIC-14
D SUFFIX
CASE 751A

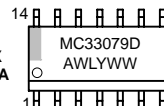

- A = Assembly Location
- WL, L = Wafer Lot
- YY, Y = Year
- WW, W = Work Week
- = Pb-Free Package

ORDERING INFORMATION

See detailed ordering and shipping information in the package dimensions section on page 10 of this data sheet.

BC817-16LT1, BC817-25LT1, BC817-40LT1

General Purpose Transistors

NPN Silicon

Features

- Pb-Free Packages are Available

MAXIMUM RATINGS

Rating	Symbol	Value	Unit
Collector – Emitter Voltage	V_{CEO}	45	V
Collector – Base Voltage	V_{CBO}	50	V
Emitter – Base Voltage	V_{EBO}	5.0	V
Collector Current – Continuous	I_C	500	mAdc

THERMAL CHARACTERISTICS

Characteristic	Symbol	Max	Unit
Total Device Dissipation FR-5 Board, (Note 1) $T_A = 25^\circ\text{C}$ Derate above 25°C	P_D	225 1.8	mW mW/ $^\circ\text{C}$
Thermal Resistance, Junction-to-Ambient	$R_{\theta JA}$	556	$^\circ\text{C}/\text{W}$
Total Device Dissipation Alumina Substrate, (Note 2) $T_A = 25^\circ\text{C}$ Derate above 25°C	P_D	300 2.4	mW mW/ $^\circ\text{C}$
Thermal Resistance, Junction-to-Ambient	$R_{\theta JA}$	417	$^\circ\text{C}/\text{W}$
Junction and Storage Temperature	T_J, T_{stg}	-55 to +150	$^\circ\text{C}$

Maximum ratings are those values beyond which device damage can occur. Maximum ratings applied to the device are individual stress limit values (not normal operating conditions) and are not valid simultaneously. If these limits are exceeded, device functional operation is not implied, damage may occur and reliability may be affected.

- FR-5 = 1.0 x 0.75 x 0.062 in.
- Alumina = 0.4 x 0.3 x 0.024 in 99.5% alumina.



ON Semiconductor®

<http://onsemi.com>

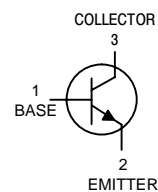

SOT-23
CASE 318
STYLE 6

MARKING DIAGRAM

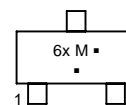

6x = Device Code
x = A, B, or C
M = Date Code*
▪ = Pb-Free Package

(Note: Microdot may be in either location)

*Date Code orientation and/or overbar may vary depending upon manufacturing location.

ORDERING INFORMATION

See detailed ordering and shipping information in the package dimensions section on page 2 of this data sheet.

Resistors

Thick film rectangular

MCR10 (2012 size : 1 / 8W)

●Features

- 1) Power rating of 1 / 8W
- 2) Highly reliable chip resistor
Ruthenium oxide dielectric offers superior resistance to the elements.
- 3) Electrodes not corroded by soldering
Thick film makes the electrodes very strong.
- 4) Leading the world in development and mass production.
Since start of production in 1982 (first in the world), this component has established a solid reputation as a general-purpose chip resistor.
- 5) ROHM resistors have approved ISO-9001 certification.
Design and specifications are subject to change without notice. Carefully check the specification sheet before using or ordering it.

●Ratings

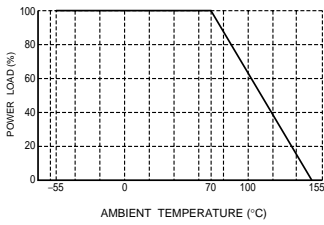
Item	Conditions	Specifications
Rated power	<p>Power must be derated according to the power derating curve in Figure 1 when ambient temperature exceeds 70°C.</p>  <p style="text-align: center;">Fig.1</p>	0.125W (1 / 8W) at 70°C
Rated voltage	<p>The voltage rating is calculated by the following equation. If the value obtained exceeds the limiting element voltage, the voltage rating is equal to the maximum operating voltage.</p> $E = \sqrt{P \times R}$ <p style="text-align: center;">E: Rated voltage (V) P: Rated power (W) R: Nominal resistance (Ω)</p>	Limiting element voltage 150V
Nominal resistance	See Table 1.	
Operating temperature		-55°C to + 155°C



INTERCONNECTS
.030" dia. Pins, Straight and Right Angle
Single Row

Series 800, 801

<p>Fig. 1</p>	<ul style="list-style-type: none"> • Receptacles accept .030" diameter and .025" square pins such as Series 890 and 892 pin headers. • Pin interconnects available with straight (MM# 7007) or right angle (MM# 5005) solder tails. (See page 173 for details) • Sockets are available with straight (MM# 1304) or right angle (MM# 1305) solder tails. (See pages 146 & 147 for details) 																
<p>Fig. 2</p>	<p>Ordering Information</p>																
<p>Fig. 3</p>	<p>Fig. 1</p>	<p>Series 800...10-001 Straight Pin Header</p> <p>800-XX-0__-10-001</p> <p>Specify # of pins → 01-64</p>															
<p>Fig. 4</p>	<p>Fig. 2</p>	<p>Series 800...20-001 Right Angle Pin Header</p> <p>800-XX-0__-20-001</p> <p>Specify # of pins → 01-64</p>															
<p>XX= Plating Code See Below</p>																	
<table border="1" style="width: 100%; border-collapse: collapse;"> <tr> <td style="width: 30%;">SPECIFY PLATING CODE XX=</td> <td style="width: 15%; text-align: center;">10</td> <td style="width: 15%; text-align: center;">90</td> <td style="width: 15%;"></td> <td style="width: 15%;"></td> </tr> <tr> <td>Pin Plating</td> <td style="text-align: center;"></td> <td style="text-align: center;"></td> <td style="text-align: center;">10μ" Au</td> <td style="text-align: center;">200μ" Sn/Pb</td> </tr> </table>			SPECIFY PLATING CODE XX=	10	90			Pin Plating			10μ" Au	200μ" Sn/Pb					
SPECIFY PLATING CODE XX=	10	90															
Pin Plating			10μ" Au	200μ" Sn/Pb													
<p>Fig. 4</p>	<p>Fig. 3</p>	<p>Series 801...10-001 Straight Socket</p> <p>801-XX-0__-10-001</p> <p>Specify # of pins → 01-50</p>															
<p>Fig. 4</p>	<p>Fig. 4</p>	<p>Series 801...20-001 Right Angle Socket</p> <p>801-XX-0__-20-001</p> <p>Specify # of pins → 01-50</p>															
<p>XX= Plating Code See Below</p>																	
<table border="1" style="width: 100%; border-collapse: collapse;"> <tr> <td style="width: 30%;">SPECIFY PLATING CODE XX=</td> <td style="width: 15%;"></td> <td style="width: 15%; text-align: center;">93</td> <td style="width: 15%; text-align: center;">99</td> <td style="width: 15%;"></td> </tr> <tr> <td>Sleeve (Pin)</td> <td style="text-align: center;"></td> <td style="text-align: center;"></td> <td style="text-align: center;">200μ" Sn/Pb</td> <td style="text-align: center;">200μ" Sn/Pb</td> </tr> <tr> <td>Contact (Clip)</td> <td style="text-align: center;"></td> <td style="text-align: center;"></td> <td style="text-align: center;">30μ" Au</td> <td style="text-align: center;">200μ" Sn/Pb</td> </tr> </table>			SPECIFY PLATING CODE XX=		93	99		Sleeve (Pin)			200μ" Sn/Pb	200μ" Sn/Pb	Contact (Clip)			30μ" Au	200μ" Sn/Pb
SPECIFY PLATING CODE XX=		93	99														
Sleeve (Pin)			200μ" Sn/Pb	200μ" Sn/Pb													
Contact (Clip)			30μ" Au	200μ" Sn/Pb													

General Multilayer Ceramic Chip Capacitors C Series

FEATURES

- High capacitance has been achieved through precision technologies that enable the use of multiple thinner ceramic dielectric layers.
- A monolithic structure ensures superior mechanical strength and reliability.
- High-accuracy automatic mounting is facilitated through the maintenance of very precise dimensional tolerances.
- Composed of only ceramics and metals, these capacitors provide extremely dependable performance, exhibiting virtually no degradation even when subjected to temperature extremes.
- Low stray capacitance ensures high conformity with nominal values, thereby simplifying the circuit design process.
- Low residual inductance assures superior frequency characteristics.
- Because electrostatic capacity has been obtained up to the electrolytic capacitor range, these capacitors offer long service life and are optimally suited for power supply designs that require high levels of reliability.
- Owing to their low ESR and excellent frequency characteristics, these products are optimally suited for high frequency and high-density type power supplies.

PRODUCT IDENTIFICATION

C 0603 CH 1H 100 D □
(1) (2) (3) (4) (5) (6) (7)

(1) Series name

(2) Dimensions L×W

0603	0.6×0.3mm
1005	1.0×0.5mm
1608	1.6×0.8mm
2012	2.0×1.25mm
3216	3.2×1.6mm
3225	3.2×2.5mm
4532	4.5×3.2mm
5750	5.7×5.0mm

(3) Capacitance temperature characteristics

Class 1 (Temperature compensation)

Temperature characteristics	Capacitance change	Temperature range
CH	0±60ppm/°C	-25 to +85°C
C0G	0±30ppm/°C	-55 to +125°C
SL	+350 to -1000ppm/°C	+20 to +85°C

Class 2

Temperature characteristics	Capacitance change	Temperature range
B(JB*)	±10%	-25 to +85°C
F(JF*)	+30, -80%	-25 to +85°C
X7R	±15%	-55 to +125°C
X5R	±15%	-55 to +85°C
Y5V	+22, -82%	-30 to +85°C

*JB(JIS: BJ), JF(JIS: FJ)

(4) Rated voltage E_{dc}

0J	6.3V
1A	10V
1C	16V
1E	25V
1H	50V

(5) Nominal capacitance

The capacitance is expressed in three digit codes and in units of pico farads (pF).

The first and second digits identify the first and second significant figures of the capacitance.

The third digit identifies the multiplier.

R designates a decimal point.

010	1pF
100	10pF
102	1,000pF
0R5	0.5pF

(6) Capacitance tolerance

Symbol	Tolerance	Applicable capacitance range
C	±0.25pF	10pF or less
D	±0.5pF	
J	±5%	Over 10pF
K	±10%	
M	±20%	
Z	+80, -20%	

(7) Packaging style

T	Taping (reel)
B	Bulk

• All specifications are subject to change without notice.

CERAMIC CHIP CAPACITORS



FEATURES

- C0G (NP0), X7R, X5R, Z5U and Y5V Dielectrics
- 10, 16, 25, 50, 100 and 200 Volts
- Standard End Metalization: Tin-plate over nickel barrier
- Available Capacitance Tolerances: ± 0.10 pF; ± 0.25 pF; ± 0.5 pF; $\pm 1\%$; $\pm 2\%$; $\pm 5\%$; $\pm 10\%$; $\pm 20\%$; and $+80\%$ - 20%
- Tape and reel packaging per EIA481-1. (See page 92 for specific tape and reel information.) Bulk Cassette packaging (0402, 0603, 0805 only) per IEC60286-6 and EIAJ 7201.
- RoHS Compliant

CAPACITOR OUTLINE DRAWINGS

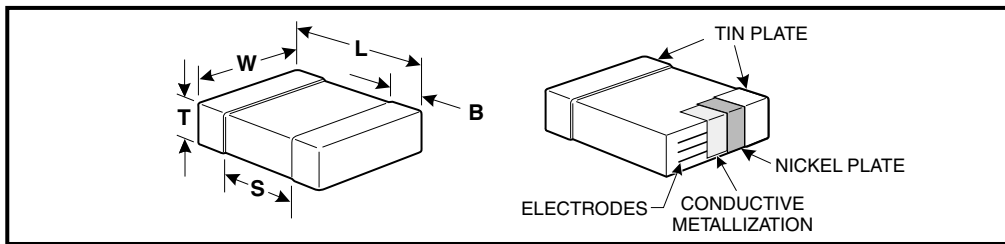

DIMENSIONS—MILLIMETERS AND (INCHES)

EIA SIZE CODE	METRIC SIZE CODE (Ref only)	L # LENGTH	W # WIDTH	See page 77 for thickness dimensions.	B		S	MOUNTING TECHNIQUE
					BANDWIDTH	MIN. SEPARATION		
0402*	1005	1.0 (.04) \pm .05 (.002)	0.5 (.02) \pm .05 (.002)		0.20 (0.008)-0.40 (0.016)	0.3 (.012)		Solder Reflow
0603*	1608	1.6 (.063) \pm 0.15 (.006)	0.8 (.032) \pm 0.15 (.006)		0.35 (.014) \pm 0.15 (.006)	0.7 (.028)		Solder Wave † or Solder Reflow
0805*	2012	2.0 (.079) \pm 0.2 (.008)	1.25 (.049) \pm 0.2 (.008)		0.5 (.02) \pm .25 (.010)	0.75 (.030)		
1206*	3216	3.2 (.126) \pm 0.2 (.008)	1.6 (.063) \pm 0.2 (.008)		0.5 (.02) \pm .25 (.010)	N/A		
1210*	3225	3.2 (.126) \pm 0.2 (.008)	2.5 (.098) \pm 0.2 (.008)		0.5 (.02) \pm .25 (.010)	N/A		Solder Reflow
1812	4532	4.5 (.177) \pm 0.3 (.012)	3.2 (.126) \pm 0.3 (.012)		0.6 (.024) \pm .35 (.014)	N/A		
1825*	4564	4.5 (.177) \pm 0.3 (.012)	6.4 (.252) \pm 0.4 (.016)		0.6 (.024) \pm .35 (.014)	N/A		
2220	5650	5.6 (.220) \pm 0.4 (.016)	5.0 (.197) \pm 0.4 (.016)		0.6 (.024) \pm .35 (.014)	N/A		
2225	5664	5.6 (.220) \pm 0.4 (.016)	6.3 (.248) \pm 0.4 (.016)		0.6 (.024) \pm .35 (.014)	N/A		

* Note: Indicates EIA Preferred Case Sizes (Tightened tolerances apply for 0402, 0603, and 0805 packaged in bulk cassette, see page 96.)
 † For extended value 1210 case size - solder reflow only.

CAPACITOR ORDERING INFORMATION (Standard Chips - For Military see page 90)

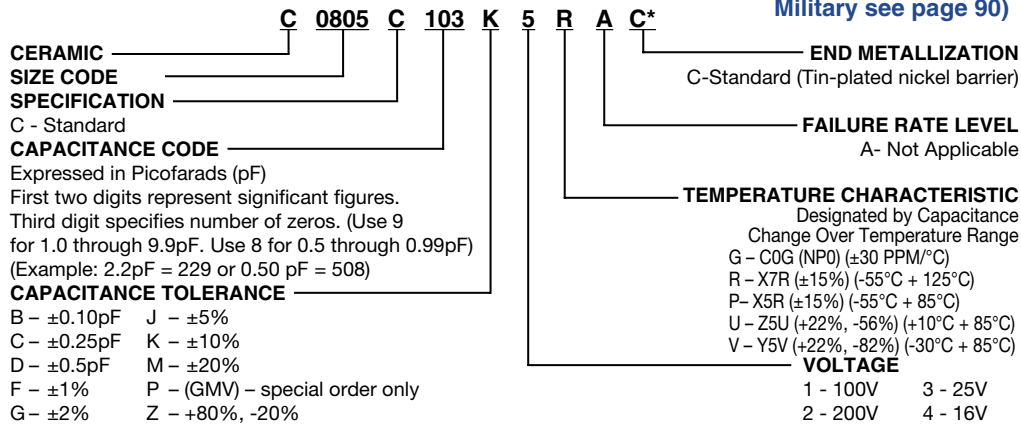

* Part Number Example: C0805C103K5RAC (14 digits - no spaces)